

Zusatzmodule zum nachträglichen Anbau an Schalter 41300/41600/71300

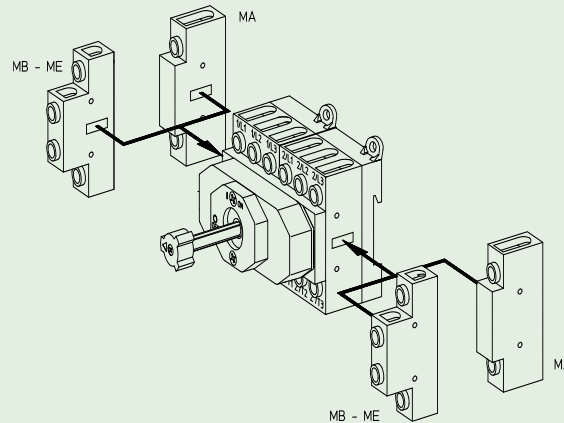

Schaltprogramm		Typ	Bestellnummer	
Modul links	Modul rechts		Fronteinbau	Bodeneinbau
Neutralleitermodul MA Frühschließer		H216 H220 H226 H233 B240 B250 B263 H406 H408 H410 H412	MAH2-16A01 MAH2-20A01 MAH2-26A01 MAH2-33A01 MAB2-40A01 MAB2-50A01 MAB2-63A01 MAH4-06A01 MAH4-08A01 MAH4-10A01 MAH4-12A01	MAH2-16A02 MAH2-20A02 MAH2-26A02 MAH2-33A02 MAB2-40A02 MAB2-50A02 MAB2-63A02 MAH4-06A02 MAH4-08A02 MAH4-10A02 MAH4-12A02
N-Klemme MF		H216 H220 H226 H233 B240 B250 B263 H406 H408 H410 H412	MFH2-00A01 MFH2-00A01 MFH2-00A01 MFH2-00A01 MFB2-00A01 MFB2-00A01 MFB2-00A01 MFH4-00A01 MFH4-00A01 MFH4-00A01 MFH4-00A01	MFH2-00A02 MFH2-00A02 MFH2-00A02 MFH2-00A02 MFB2-00A02 MFB2-00A02 MFB2-00A02 MFH4-00A02 MFH4-00A02 MFH4-00A02 MFH4-00A02
PE-Klemme MG		H216 H220 H226 H233 B240 B250 B263 H406 H408 H410 H412	MGH2-00A01 MGH2-00A01 MGH2-00A01 MGH2-00A01 MGB2-00A01 MGB2-00A01 MGB2-00A01 MGH4-00A01 MGH4-00A01 MGH4-00A01 MGH4-00A01	MGH2-00A02 MGH2-00A02 MGH2-00A02 MGH2-00A02 MGB2-00A02 MGB2-00A02 MGB2-00A02 MGH4-00A02 MGH4-00A02 MGH4-00A02 MGH4-00A02
Hauptkontaktmodul MO gleichzeitig schließend		H216 H220 H226 H233 B240 B250 B263 H406 H408 H410 H412	MOH2-16A01 MOH2-20A01 MOH2-26A01 MOH2-33A01 MOB2-40A01 MOB2-50A01 MOB2-63A01 MOH4-06A01 MOH4-08A01 MOH4-10A01 MOH4-12A01	MOH2-16A02 MOH2-20A02 MOH2-26A02 MOH2-33A02 MOB2-40A02 MOB2-50A02 MOB2-63A02 MOH4-06A02 MOH4-08A02 MOH4-10A02 MOH4-12A02



Lasttrennschalter

Technische Informationen Zusatzmodule

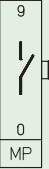
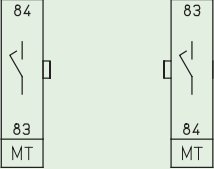
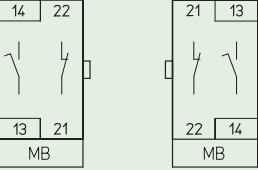
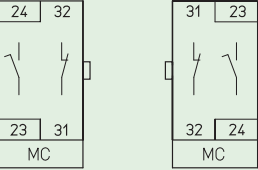
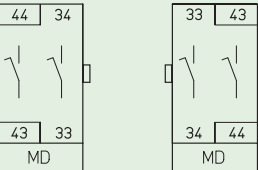
Zusatzmodule zum nachträglichen Anbau an Schalter 41300/41600/71300

Schaltprogramm		Typ	Bestellnummer Fronteinbau	Bestellnummer Bodeneinbau		
Modul links	Modul rechts					
Hauptkontaktmodul MP gleichzeitig schließend		H216	MPH2-16A01	MPH2-16A02		
		H220	MPH2-20A01	MPH2-20A02		
		H226	MPH2-26A01	MPH2-26A02		
		H233	MPH2-33A01	MPH2-33A02		
		B240	MPB2-40A01	MPB2-40A02		
		B250	MPB2-50A01	MPB2-50A02		
		B263	MPB2-63A01	MPB2-63A02		
		H406	MPH4-06A01	MPH4-06A02		
		H408	MPH4-08A01	MPH4-08A02		
		H410	MPH4-10A01	MPH4-10A02		
		H412	MPH4-12A01	MPH4-12A02		
		Hauptkontaktmodul MT 1 Frühschließer 20A		H216	MTH2-20A01	MTH2-20A02
				H220	MTH2-20A01	MTH2-20A02
				H226	MTH2-20A01	MTH2-20A02
H233	MTH2-20A01			MTH2-20A02		
B240	MTB2-20A01			MTB2-20A02		
B250	MTB2-20A01			MTB2-20A02		
B263	MTB2-20A01			MTB2-20A02		
H406	MTH4-20A01			MTH4-20A02		
H408	MTH4-20A01			MTH4-20A02		
H410	MTH4-20A01			MTH4-20A02		
H412	MTH4-20A01			MTH4-20A02		
Hilfskontaktmodul MB 1 Spätschließer/Frühöffner + 1 Öffner				H216	MBH2-11A01	MBH2-11A02
				H220	MBH2-11A01	MBH2-11A02
				H226	MBH2-11A01	MBH2-11A02
		H233	MBH2-11A01	MBH2-11A02		
		B240	MBH4-11A01	MBH4-11A02		
		B250	MBH4-11A01	MBH4-11A02		
		B263	MBH4-11A01	MBH4-11A02		
		H406	MBH4-11A01	MBH4-11A02		
		H408	MBH4-11A01	MBH4-11A02		
		H410	MBH4-11A01	MBH4-11A02		
		H412	MBH4-11A01	MBH4-11A02		
		Hilfskontaktmodul MC 1 Spätschließer/Frühöffner + 1 Öffner		H216	MCH2-11A01	MCH2-11A02
				H220	MCH2-11A01	MCH2-11A02
				H226	MCH2-11A01	MCH2-11A02
H233	MCH2-11A01			MCH2-11A02		
B240	MCH4-11A01			MCH4-11A02		
B250	MCH4-11A01			MCH4-11A02		
B263	MCH4-11A01			MCH4-11A02		
H406	MCH4-11A01			MCH4-11A02		
H408	MCH4-11A01			MCH4-11A02		
H410	MCH4-11A01			MCH4-11A02		
H412	MCH4-11A01			MCH4-11A02		
Hilfskontaktmodul MD 2 Spätschließer/Frühöffner				H216	MDH2-20A01	MDH2-20A02
				H220	MDH2-20A01	MDH2-20A02
				H226	MDH2-20A01	MDH2-20A02
		H233	MDH2-20A01	MDH2-20A02		
		B240	MDH4-20A01	MDH4-20A02		
		B250	MDH4-20A01	MDH4-20A02		
		B263	MDH4-20A01	MDH4-20A02		
		H406	MDH4-20A01	MDH4-20A02		
		H408	MDH4-20A01	MDH4-20A02		
		H410	MDH4-20A01	MDH4-20A02		
		H412	MDH4-20A01	MDH4-20A02		

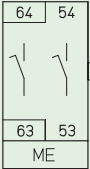
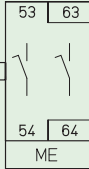
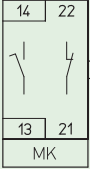
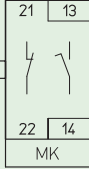
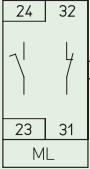
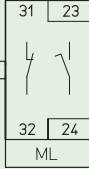
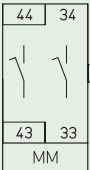
Zusatzmodule zum nachträglichen Anbau an Schalter 41300 /41600/71300

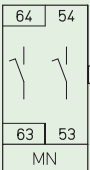
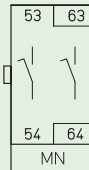
Schaltprogramm		Typ	Bestellnummer Fronteinbau	Bestellnummer Bodeneinbau
Modul links	Modul rechts			
Hilfskontaktmodul ME 2 Spätschließer/Frühöffner		H216	MEH2-20A01	MEH2-20A02
		H220	MEH2-20A01	MEH2-20A02
		H226	MEH2-20A01	MEH2-20A02
		H233	MEH2-20A01	MEH2-20A02
		B240	MEH4-20A01	MEH4-20A02
		B250	MEH4-20A01	MEH4-20A02
		B263	MEH4-20A01	MEH4-20A02
		H406	MEH4-20A01	MEH4-20A02
		H408	MEH4-20A01	MEH4-20A02
		H410	MEH4-20A01	MEH4-20A02
		H412	MEH4-20A01	MEH4-20A02
Hilfskontaktmodul MK 1 Spätschließer/Frühöffner + 1 Öffner Kontakte mit Goldauflage 5 µm		H216	MKH2-11A01	MKH2-11A02
		H220	MKH2-11A01	MKH2-11A02
		H226	MKH2-11A01	MKH2-11A02
		H233	MKH2-11A01	MKH2-11A02
		B240	MKH4-11A01	MKH4-11A02
		B250	MKH4-11A01	MKH4-11A02
		B263	MKH4-11A01	MKH4-11A02
		H406	MKH4-11A01	MKH4-11A02
		H408	MKH4-11A01	MKH4-11A02
		H410	MKH4-11A01	MKH4-11A02
		H412	MKH4-11A01	MKH4-11A02
Hilfskontaktmodul ML 1 Spätschließer/Frühöffner + 1 Öffner Kontakte mit Goldauflage 5 µm		H216	MLH2-11A01	MLH2-11A02
		H220	MLH2-11A01	MLH2-11A02
		H226	MLH2-11A01	MLH2-11A02
		H233	MLH2-11A01	MLH2-11A02
		B240	MLH4-11A01	MLH4-11A02
		B250	MLH4-11A01	MLH4-11A02
		B263	MLH4-11A01	MLH4-11A02
		H406	MLH4-11A01	MLH4-11A02
		H408	MLH4-11A01	MLH4-11A02
		H410	MLH4-11A01	MLH4-11A02
		H412	MLH4-11A01	MLH4-11A02
Hilfskontaktmodul MM 2 Spätschließer/Frühöffner Kontakte mit Goldauflage 5 µm		H216	MMH2-20A01	MMH2-20A02
		H220	MMH2-20A01	MMH2-20A02
		H226	MMH2-20A01	MMH2-20A02
		H233	MMH2-20A01	MMH2-20A02
		B240	MMH4-20A01	MMH4-20A02
		B250	MMH4-20A01	MMH4-20A02
		B263	MMH4-20A01	MMH4-20A02
		H406	MMH4-20A01	MMH4-20A02
		H408	MMH4-20A01	MMH4-20A02
		H410	MMH4-20A01	MMH4-20A02
		H412	MMH4-20A01	MMH4-20A02
Hilfskontaktmodul MN 2 Spätschließer/Frühöffner Kontakte mit Goldauflage 5 µm		H216	MNH2-20A01	MNH2-20A02
		H220	MNH2-20A01	MNH2-20A02
		H226	MNH2-20A01	MNH2-20A02
		H233	MNH2-20A01	MNH2-20A02
		B240	MNH4-20A01	MNH4-20A02
		B250	MNH4-20A01	MNH4-20A02
		B263	MNH4-20A01	MNH4-20A02
		H406	MNH4-20A01	MNH4-20A02
		H408	MNH4-20A01	MNH4-20A02
		H410	MNH4-20A01	MNH4-20A02
		H412	MNH4-20A01	MNH4-20A02

Lasttrennschalter

Technische Informationen Zusatzmodule

Zusatzmodule zum nachträglichen Anbau an Schalter 41300/41600/71300

Schaltprogramm		Typ	Bestellnummer Fronteinbau	Bestellnummer Bodeneinbau											
Modul links	Modul rechts														
Hilfskontaktmodul MR 1 Schließer + 1 Öffner		H216 H220 H226 H233 B240 B250 B263	MRH2-11A01 MRH2-11A01 MRH2-11A01 MRH2-11A01 MRB2-11A01 MRB2-11A01 MRB2-11A01	MRH2-11A02 MRH2-11A02 MRH2-11A02 MRH2-11A02 MRB2-11A02 MRB2-11A02 MRB2-11A02											
Hilfskontaktmodul MU 2 Öffner					H216 H220 H226 H233 B240 B250 B263	MUH2-02A01 MUH2-02A01 MUH2-02A01 MUH2-02A01 MUB2-02A01 MUB2-02A01 MUB2-02A01	MUH2-02A02 MUH2-02A02 MUH2-02A02 MUH2-02A02 MUB2-02A02 MUB2-02A02 MUB2-02A02								
Klemmpunktmodul MX 4 Klemmenstützpunkte 2,5 mm ²								H216 H220 H226 H233 B240 B250 B263 H406 H408 H410 H412	— — — — — — — — — —	MXH2-04A02 MXH2-04A02 MXH2-04A02 MXH2-04A02 MXH4-04A02 MXH4-04A02 MXH4-04A02 MXH4-04A02 MXH4-04A02 MXH4-04A02 MXH4-04A02					
Verbindungsbrücke neutral zur Verbindung der Neutralleiter- module MA beim Umschalter 71400											H200 B200 H400	224234 224301 404111	224234 224303 404111		

Zusatzschilder/Achsverlängerungen

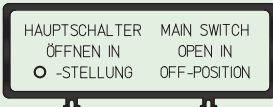

Beispiel: FAZ2-8041

Zusatzschilder

mit Zusatzbeschriftung zum nachträglichen Aufstecken auf Frontschilder und Vorhängeschlossperren

Bestellnummer

- Schildrahmen schwarz, Schrifteinlage silber, unbeschriftet (gravierbar) **FAZ2 - 8000**
- Schildrahmen schwarz, Schrifteinlage silber, Beschriftung schwarz, Beschriftung s. "Aufschriften für Zusatzschilder" **FAZ2 - 8...**
- Schildrahmen schwarz, Schrifteinlage silber, Beschriftung schwarz, Sonderbeschriftung **FAZ2 - (Sonder-Nr.)**
- Schildrahmen schwarz, Schrifteinlage gelb, unbeschriftet (gravierbar) **FBZ2 - 8000**
- Schildrahmen schwarz, Schrifteinlage gelb, Beschriftung schwarz, Beschriftung s. "Aufschriften für Zusatzschilder" **FBZ2 - 8...**
- Schildrahmen schwarz, Schrifteinlage gelb, Beschriftung schwarz, Sonderbeschriftung **FBZ2 - (Sonder-Nr.)**
- Schildrahmen schwarz (ohne Schrifteinlage) **FAZ2**

Schrifteinlagen für Zusatzschilder

- Schrifteinlage silber unbeschriftet (gravierbar) **FAS2 - 8000**
- Schrifteinlage silber, Beschriftung schwarz, Beschriftung s. "Aufschriften für Zusatzschilder" **FAS2 - 8...**
- Schrifteinlage silber, Beschriftung schwarz, Sonderbeschriftung **FAS2 - (Sonder-Nr.)**
- Schrifteinlage gelb, unbeschriftet (gravierbar) **FBS2 - 8000**
- Schrifteinlage gelb, Beschriftung schwarz, Beschriftung s. "Aufschriften für Zusatzschilder" **FBS2 - 8...**
- Schrifteinlage gelb, Beschriftung schwarz, Sonderbeschriftung **FBS2 - (Sonder-Nr.)**

Aufschriften für Zusatzschilder

FA 8000	FA 8001	FA 8002	FA 8003	FA 8013	FA 8026	FA 8027
FA 8028	FA 8029	FA 8030	FA 8031	FA 8037	FA 8039	FA 8040
FA 8041	FA 8044	FA 8045	FA 8046	FA 8047		

Modularachsverlängerungen für Bauformen mit Türverriegelung (bitte getrennt bestellen!)

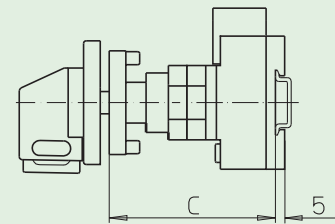
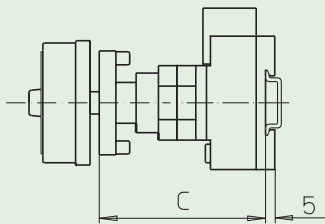
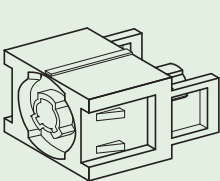

H216/H220/H226/H233 B240/B250/B263	H216/H220/H226/H233 B240/B250/B263	H406/H408/H410/H412	H406/H408/H410/H412	Bestellnummer
3...4-polige Haupt-/Notausschalter 3...4-polige Hauptschalter 3...4-polige Ein-/Ausschalter	6...8-polige Haupt-/Notausschalter 6...8-polige Hauptschalter 6...8-polige Ein-/Ausschalter 3...4-polige Umschalter	3...4-polige Haupt-/Notausschalter 3...4-polige Hauptschalter 3...4-polige Ein-/Ausschalter	6...8-polige Haupt-/Notausschalter 6...8-polige Hauptschalter 6...8-polige Ein-/Ausschalter 3...4-polige Umschalter	H216 B240 H406 H220 B250 H408 H226 B263 H410 H233 H412

Abmessung C (Einbaumaß: Innenseite Tür bis Oberkante Tragschiene):

092 ... 107 mm	100 ... 115 mm	103 ... 117 mm	116 ... 130 mm	-	-
114 ... 132 mm	122 ... 140 mm	124 ... 142 mm	137 ... 155 mm	AVC2-1	AVC4-1
139 ... 157 mm	147 ... 165 mm	149 ... 167 mm	162 ... 180 mm	AVC2-2	AVC4-2
164 ... 182 mm	172 ... 190 mm	174 ... 192 mm	187 ... 205 mm	AVC2-3	AVC4-3
189 ... 207 mm	197 ... 215 mm	199 ... 217 mm	212 ... 230 mm	AVC2-4	AVC4-4

Lasttrennschalter

Technische Informationen Zubehör

Metallachsen

Metallachsen für Bauformen mit Türverriegelung (bitte getrennt bestellen!)

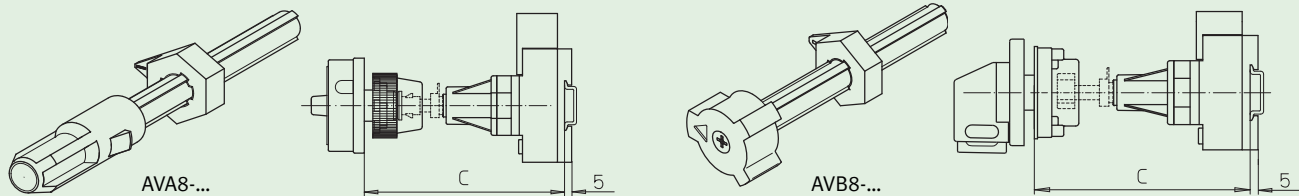

H216/H220/H226/H233 B240/B250/B263	B240/B250/B263	H216/H220/H226/H233	H406/H408/H410/H412	H406/H408/H410/H412	Bestellnummer
3...4-pol. Haupt-/Notausschalter 3...4-polige Hauptschalter 3...4-polige Ein-/Ausschalter	6...8-pol. Haupt-/Notausschalter 6...8-polige Hauptschalter 6...8-polige Ein-/Ausschalter 3...4-polige Umschalter	6...8-pol. Haupt-/Notausschalter 6...8-polige Hauptschalter 6...8-polige Ein-/Ausschalter 3...4-polige Umschalter	3...4-pol. Haupt-/Notausschalter 3...4-polige Hauptschalter 3...4-polige Ein-/Ausschalter	6...8-pol. Haupt-/Notausschalter 6...8-polige Hauptschalter 6...8-polige Ein-/Ausschalter 3...4-polige Umschalter	

Zentralbefestigung frontseitig

Abmessung C (Einbaumaß: Außenseite Tür bis Oberkante Tragschiene):

155 ... 173 mm	163 ... 183 mm	167 ... 185 mm	165 ... 183 mm	177 ... 195 mm	AVA8 - 065
174 ... 198 mm	182 ... 206 mm	186 ... 210 mm	184 ... 208 mm	196 ... 220 mm	AVA8 - 090
199 ... 223 mm	207 ... 231 mm	211 ... 235 mm	209 ... 233 mm	221 ... 245 mm	AVA8 - 115
224 ... 248 mm	232 ... 256 mm	236 ... 260 mm	234 ... 258 mm	246 ... 270 mm	AVA8 - 140
249 ... 273 mm	257 ... 281 mm	261 ... 285 mm	259 ... 283 mm	271 ... 295 mm	AVA8 - 165
274 ... 298 mm	282 ... 306 mm	286 ... 310 mm	284 ... 308 mm	296 ... 320 mm	AVA8 - 190
299 ... 323 mm	307 ... 331 mm	311 ... 335 mm	309 ... 333 mm	321 ... 345 mm	AVA8 - 215
324 ... 348 mm	332 ... 356 mm	336 ... 360 mm	334 ... 358 mm	346 ... 370 mm	AVA8 - 240
349 ... 373 mm	357 ... 381 mm	361 ... 385 mm	359 ... 383 mm	371 ... 395 mm	AVA8 - 265
374 ... 398 mm	382 ... 406 mm	386 ... 410 mm	384 ... 408 mm	396 ... 420 mm	AVA8 - 290
399 ... 423 mm	407 ... 431 mm	411 ... 435 mm	409 ... 433 mm	421 ... 445 mm	AVA8 - 315
424 ... 448 mm	432 ... 456 mm	436 ... 460 mm	434 ... 458 mm	446 ... 470 mm	AVA8 - 340
449 ... 473 mm	457 ... 481 mm	461 ... 485 mm	459 ... 483 mm	471 ... 495 mm	AVA8 - 365
474 ... 498 mm	482 ... 506 mm	486 ... 510 mm	484 ... 508 mm	496 ... 520 mm	AVA8 - 390
499 ... 523 mm	507 ... 531 mm	511 ... 535 mm	509 ... 533 mm	521 ... 545 mm	AVA8 - 415
524 ... 548 mm	532 ... 556 mm	536 ... 560 mm	534 ... 558 mm	546 ... 570 mm	AVA8 - 440
549 ... 573 mm	557 ... 581 mm	561 ... 585 mm	559 ... 583 mm	571 ... 595 mm	AVA8 - 465
574 ... 598 mm	582 ... 606 mm	586 ... 610 mm	584 ... 608 mm	596 ... 620 mm	AVA8 - 490
599 ... 623 mm	607 ... 631 mm	611 ... 635 mm	609 ... 633 mm	621 ... 645 mm	AVA8 - 515
624 ... 643 mm	632 ... 656 mm	636 ... 660 mm	634 ... 658 mm	646 ... 670 mm	AVA8 - 540

Vierlochbefestigung frontseitig

Abmessung C (Einbaumaß: Innenseite Tür bis Oberkante Tragschiene):

140 ... 164 mm	148 ... 172 mm	152 ... 176 mm	150 ... 174 mm	162 ... 186 mm	AVB8 - 065
165 ... 189 mm	173 ... 197 mm	177 ... 201 mm	175 ... 199 mm	187 ... 211 mm	AVB8 - 090
190 ... 214 mm	198 ... 222 mm	202 ... 226 mm	200 ... 224 mm	212 ... 236 mm	AVB8 - 115
215 ... 239 mm	223 ... 247 mm	227 ... 251 mm	225 ... 249 mm	237 ... 261 mm	AVB8 - 140
240 ... 264 mm	248 ... 272 mm	252 ... 276 mm	250 ... 274 mm	262 ... 286 mm	AVB8 - 165
265 ... 289 mm	276 ... 297 mm	277 ... 301 mm	275 ... 299 mm	287 ... 311 mm	AVB8 - 190
290 ... 314 mm	298 ... 322 mm	302 ... 326 mm	300 ... 324 mm	312 ... 336 mm	AVB8 - 215
315 ... 339 mm	323 ... 347 mm	327 ... 351 mm	325 ... 349 mm	337 ... 361 mm	AVB8 - 240
340 ... 364 mm	348 ... 372 mm	352 ... 376 mm	350 ... 374 mm	362 ... 386 mm	AVB8 - 265
365 ... 389 mm	373 ... 397 mm	377 ... 401 mm	375 ... 399 mm	387 ... 411 mm	AVB8 - 290
390 ... 414 mm	398 ... 422 mm	402 ... 426 mm	400 ... 424 mm	412 ... 436 mm	AVB8 - 315
415 ... 439 mm	423 ... 447 mm	427 ... 451 mm	425 ... 449 mm	437 ... 461 mm	AVB8 - 340
440 ... 464 mm	448 ... 472 mm	452 ... 476 mm	450 ... 474 mm	462 ... 486 mm	AVB8 - 365
465 ... 489 mm	473 ... 497 mm	477 ... 501 mm	475 ... 499 mm	487 ... 511 mm	AVB8 - 390
490 ... 514 mm	498 ... 522 mm	502 ... 526 mm	500 ... 524 mm	512 ... 536 mm	AVB8 - 415
515 ... 539 mm	523 ... 547 mm	527 ... 551 mm	525 ... 549 mm	537 ... 561 mm	AVB8 - 440
540 ... 564 mm	548 ... 572 mm	552 ... 576 mm	550 ... 574 mm	562 ... 586 mm	AVB8 - 465
565 ... 589 mm	573 ... 597 mm	577 ... 601 mm	575 ... 599 mm	587 ... 611 mm	AVB8 - 490
590 ... 614 mm	598 ... 622 mm	602 ... 626 mm	600 ... 624 mm	612 ... 636 mm	AVB8 - 515
615 ... 639 mm	625 ... 649 mm	627 ... 651 mm	625 ... 649 mm	637 ... 661 mm	AVB8 - 540

Klemmenabdeckungen

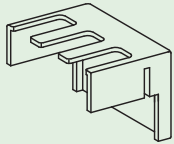

TCA/TCC

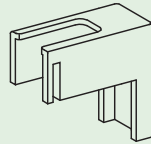

TCB/TCB

Klemmenabdeckungen sind verwendbar für Fronteinbau und Bodeneinbau. Bei der Produktreihe H400 gehören Klemmenabdeckungen zum Lieferumfang der Bauformen für Hauptschalter und Haupt-/Notausschalter und müssen nicht separat bestellt werden.

Bedingt durch das Schaltprogramm werden unterschiedliche Klemmenabdeckungen benötigt. Bitte geben Sie bei Ihrer Bestellung die entsprechende Stückzahl an!

H216/H220/H226/H233

Schaltprogramme	Stück	Bestellnummer	Stück	Bestellnummer
41200, 41211, 41220, 41222, 41231, 41240	1	TCA2	–	–
41300, 41311, 41320, 41322, 41331, 41340	1	TCA2	–	–
41400, 41411, 41420	1	TCA2	1	TCB2
41600, 41611, 41620, 41622, 41631, 41640	2	TCA2	–	–
41800	2	TCA2	2	TCB2
42400, 42411, 42420	1	TCA2	1	TCB2
42500	1	TCA2	2	TCB2
42700, 42711, 42720	2	TCA2	1	TCB2
42800	2	TCA2	2	TCB2
45300, 45311, 45320, 46300, 46311, 46320	1	TCA2	–	–
47200, 47211, 47220, 47300, 47311, 47320	1	TCA2	–	–
47400, 48400	1	TCA2	1	TCB2

B240/B250/B263

für Anschlussquerschnitt bis max. 16 mm²

Schaltprogramme	Stück	Bestellnummer	Stück	Bestellnummer
41200, 41211, 41220, 41222, 41231, 41240	1	TCC2	–	–
41300, 41311, 41320, 41322, 41331, 41340	1	TCC2	–	–
41400, 41411, 41420	1	TCC2	1	TCB2
41600, 41611, 41620, 41622, 41631, 41640	2	TCC2	–	–
41800	2	TCC2	2	TCB2
42400, 42411, 42420	1	TCC2	1	TCB2
42500	1	TCC2	2	TCB2
42700, 42711, 42720	2	TCC2	1	TCB2
42800	2	TCC2	2	TCB2
45300, 45311, 45320, 46300, 46311, 46320	1	TCC2	–	–
47200, 47211, 47220, 47300, 47311, 47320	1	TCC2	–	–
47400, 48400	1	TCC2	1	TCB2

H406/H408/H410/H412

Schaltprogramme	Stück	Bestellnummer	Stück	Bestellnummer
41200, 41211, 41220, 41222, 41231, 41240	1	TCA4	–	–
41300, 41311, 41320, 41322, 41331, 41340	1	TCA4	–	–
41400, 41411, 41420	1	TCA4	1	TCB4
41600, 41611, 41620, 41622, 41631, 41640	2	TCA4	–	–
41800	2	TCA4	2	TCB4
42400, 42411, 42420	1	TCA4	1	TCB4
42500	1	TCA4	2	TCB4
42700, 42711, 42720	2	TCA4	1	TCB4
42800	2	TCA4	2	TCB4
45300, 45311, 45320, 46300, 46311, 46320	1	TCA4	–	–
47200, 47211, 47220, 47300, 47311, 47320	1	TCA4	–	–
47400, 48400	1	TCA4	1	TCB4

Lasttrennschalter

Technische Informationen **Zubehör**

Montageschlüssel/Befestigungslaschen

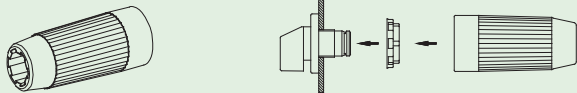

218098

Montageschlüssel für Zentralbefestigung

geeignet zur schnellen Montage von Frontschildern und Vorhängeschlosssperrern in Zentralbefestigung

Typen	Bestellnummer
H216, H220, H226, H233, B240, B250, B263	218098

Befestigungslaschen zur Außenbefestigung der Gehäuse (1 Satz)

M6 × 16



Befestigungslasche

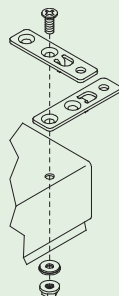
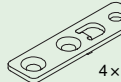

Gehäuse	Abmessungen	Bestellnummer
Stahlgehäuse	150 × 150 × 120 mm	SAX1
Stahlgehäuse	200 × 150 × 120 mm	SAX1
Stahlgehäuse	300 × 250 × 120 mm	SAX1
Edelstahlgehäuse	150 × 150 × 120 mm	SBX1
Edelstahlgehäuse	200 × 150 × 120 mm	SBX1
Edelstahlgehäuse	300 × 250 × 120 mm	SBX1



Antriebsvarianten für Bauformen mit Vorhängeschlossperre

Antrieb Verwendbar für Typen		Farbe Frontschild	Farbe Schrifteinlage	Farbe Antrieb	Bestellnummer- änderung
N-Vorhängeschlossperre H216, H220, H226, H233 B240, B250, B263 H406, H408, H410, H412 K616		schwarz	weiß	schwarz	... - - ...N1
		grau	weiß	grau	... - - ...N2
		gelb	weiß	rot	... - - ...N4
		grau	weiß	schwarz	... - - ...N6
		gelb	weiß	schwarz	... - - ...N7
		Außenabmessung Antrieb 67 x 67 mm 88 x 88 mm	max. Anzahl Vorhängeschlösser 3 4	Bügeldurchmesser Schloss 4 mm (min) / 8 mm (max) 5 mm (min) / 9 mm (max)	
M-Vorhängeschlossperre H216, H220, H226, H233 B240, B250, B263 H406, H408, H410, H412 K616		schwarz	weiß	schwarz	... - - ...M1
		grau	weiß	grau	... - - ...M2
		gelb	weiß	rot	... - - ...M4
		grau	weiß	schwarz	... - - ...M6
		gelb	weiß	schwarz	... - - ...M7
		Außenabmessung Antrieb 48 x 48 mm 67 x 67 mm 88 x 88 mm	max. Anzahl Vorhängeschlösser 3 3 4	Bügeldurchmesser Schloss 3 mm (min) / 5 mm (max) 4 mm (min) / 8 mm (max) 5 mm (min) / 9 mm (max)	
B-Vorhängeschlossperre H406, H408, H410, H412 K616 K830		schwarz	silber	schwarz	... - - ...B1
		schwarz	gelb	rot	... - - ...B4
		schwarz	schwarz	schwarz	... - - ...B8
		Außenabmessung Antrieb 75 x 114 mm 98 x 142 mm 130 x 178 mm	max. Anzahl Vorhängeschlösser 4 4 4	Bügeldurchmesser Schloss 5 mm (min) / 8 mm (max) 5 mm (min) / 8 mm (max) 5 mm (min) / 8 mm (max)	
H-Vorhängeschlossperre H406, H408, H410, H412 K616 K830		schwarz	silber	schwarz	... - - ...H1
		schwarz	gelb	rot	... - - ...H4
		schwarz	schwarz	schwarz	... - - ...H8
		Außenabmessung Antrieb 75 x 114 mm 98 x 142 mm 130 x 178 mm	max. Anzahl Vorhängeschlösser 4 4 4	Bügeldurchmesser Schloss 5 mm (min) / 8 mm (max) 5 mm (min) / 8 mm (max) 5 mm (min) / 8 mm (max)	
Griffverriegelung mit V-Griff H216, H220, H226, H233 B240, B250, B263 H406, H408, H410, H412		schwarz	silber	schwarz	... - - ...V1
		schwarz	gelb	rot	... - - ...V4
		Außenabmessung Antrieb 48 x 48 mm 64 x 64 mm	max. Anzahl Vorhängeschlösser 2 3	Bügeldurchmesser Schloss 3 mm (min) / 5 mm (max) 4 mm (min) / 6 mm (max)	
Verteilereinbau mit Frontschild für 45 mm Normausschnitt:					
Griffverriegelung mit V-Griff H216, H220, H226, H233 B240, B250, B263 H406, H408, H410, H412		grau	silber	schwarz	... - - ...V1
		grau	gelb	rot	... - - ...V4
		Verriegelungsgriff Größe 2	max. Anzahl Vorhängeschlösser 2	Bügeldurchmesser Schloss 3 mm (min) / 5 mm (max)	
Griffverriegelung mit V-Griff (Frontschild bedruckt) H406, H408, H410, H412		grau	–	schwarz	... - - ...V1
		gelb	–	rot	... - - ...V4
		Verriegelungsgriff Größe 4	max. Anzahl Vorhängeschlösser 3	Bügeldurchmesser Schloss 4 mm (min) / 6 mm (max)	

Lasttrennschalter

Technische Informationen Antriebe

Antriebsvarianten für Bauformen mit Frontschild und Griff

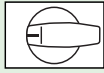
Antrieb Verwendbar für Typen		Farbe Frontschild	Farbe Schrifteinlage	Farbe Antrieb	Bestellnummer- änderung
M-Griff H216, H220, H226, H233 B240, B250, B263 H406, H408, H410, H412 K616		schwarz grau weiß schwarz schwarz schwarz	silber silber silber gelb silber schwarz	schwarz grau weiß rot rot schwarz - - ...M1 - - ...M2 - - ...M3 - - ...M4 - - ...M5 - - ...M8
F-Griff H216, H220, H226, H233 B240, B250, B263 H406, H408, H410, H412 K616		schwarz grau weiß schwarz schwarz schwarz	silber silber silber gelb silber schwarz	schwarz grau weiß rot rot schwarz - - ...F1 - - ...F2 - - ...F3 - - ...F4 - - ...F5 - - ...F8
B-Griff H216, H220, H226, H233 B240, B250, B263 H406, H408, H410, H412 K616		schwarz grau weiß schwarz schwarz schwarz	silber silber silber gelb silber schwarz	schwarz grau weiß rot rot schwarz - - ...B1 - - ...B2 - - ...B3 - - ...B4 - - ...B5 - - ...B8
N-Griff H216, H220, H226, H233 B240, B250, B263		schwarz grau weiß schwarz schwarz schwarz	silber silber silber gelb silber schwarz	schwarz grau weiß rot rot schwarz - - ...N1 - - ...N2 - - ...N3 - - ...N4 - - ...N5 - - ...N8
G-Griff H406, H408, H410, H412 K616 K830		schwarz schwarz schwarz schwarz	silber gelb silber schwarz	schwarz rot rot schwarz - - ...G1 - - ...G4 - - ...G5 - - ...G8
R-Griff H216, H220, H226, H233 B240, B250, B263		schwarz grau weiß schwarz schwarz	silber silber silber gelb silber	schwarz grau weiß rot rot - - ...R1 - - ...R2 - - ...R3 - - ...R4 - - ...R5
Verteilereinbau mit Frontschild für 45 mm Normausschnitt:					
M-Griff H216, H220, H226, H233 B240, B250, B263 H406, H408, H410, H412		grau grau grau	silber silber gelb	schwarz grau rot - - ...M1 - - ...M2 - - ...M4
M-Griff (Frontschild bedruckt) H406, H408, H410, H412		grau grau gelb	– – –	schwarz grau rot - - ...M1 - - ...M2 - - ...M4
N-Griff H216, H220, H226, H233 B240, B250, B263		grau grau grau	silber silber gelb	schwarz grau rot - - ...N1 - - ...N2 - - ...N4